

M3

MicTrak

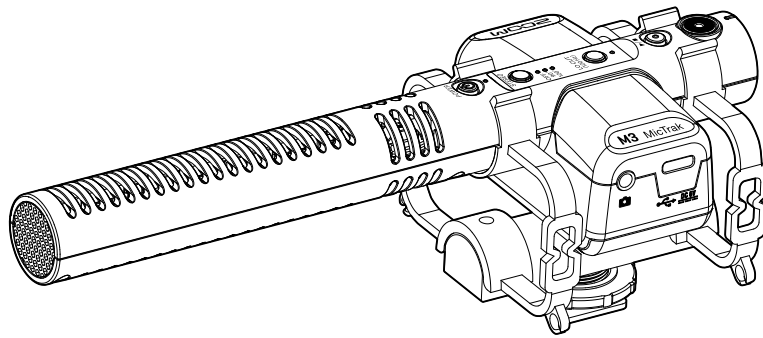

Operation Manual

You must read the Usage and Safety Precautions before use.

©2022 ZOOM CORPORATION

Copying or reprinting this manual in part or in whole without permission is prohibited.

Product names, registered trademarks and company names in this document are the property of their respective companies. All trademarks and registered trademarks in this document are for identification purposes only and are not intended to infringe on the copyrights of their respective owners.

Proper display is not possible on grayscale devices.

Notes about this Operation Manual

You might need this manual in the future. Always keep it in a place where you can access it easily. The contents of this document and the specifications of the product could be changed without notice.

- Windows® is a trademark or registered trademark of Microsoft® Corporation.
- Mac, macOS and iPad are registered trademarks of Apple Inc. in the USA and other countries
- iOS is a trademark or registered trademark of Cisco Systems, Inc. in the USA and other countries, and it is used under license.
- Android is a trademark of Google LLC.
- The microSDXC logo is a trademark of SD-3C LLC.
- Recording from copyrighted sources, including CDs, records, tapes, live performances, video works and broadcasts, without permission of the copyright holder for any purpose other than personal use is prohibited by law. ZOOM CORPORATION will not assume any responsibility related to infringements of copyrights.

Contents

Notes about this Operation Manual.....	2
M3 overview.....	5
Realizing high audio quality throughout recording and editing.....	5
Super directivity realized.....	9
Mid-side format sound capture system.....	9
Functions of parts.....	10
Recording process.....	14
Making preparations.....	15
Supplying power.....	15
Inserting microSD cards.....	17
Formatting the microSD card while starting up.....	18
Starting up without formatting the microSD card.....	20
Turning the power off.....	20
Attaching to a camera.....	21
Making hardware settings.....	22
Making input settings.....	23
Adjusting the stereo width.....	23
Reducing noise (low-frequency cut).....	24
Recording.....	25
Monitoring input sounds.....	25
Recording.....	26
Playing recordings.....	27
Managing files.....	28
M3 folder and file structure.....	28
Transferring files to computers.....	30
Using as a USB mic.....	32
Connecting computers, smartphones and tablets.....	32
Managing the firmware.....	34
Checking the firmware version.....	34
Updating the firmware.....	34
Using M3 Edit & Play.....	35
M3 Edit & Play screen overview.....	35
Installing M3 Edit & Play.....	37
Making and checking various M3 settings.....	38
Selecting files.....	40
Playing files.....	41
Using the export function.....	44
M3 Edit & Play application menu.....	46
Appendix.....	47
Troubleshooting.....	47

M3 overview

Realizing high audio quality throughout recording and editing

With dual A/D converter circuits and support for 32-bit float WAV files, the M3 can maintain the highest audio quality from recording to editing.

Recording

Dual AD converter circuits enable recording from quiet to loud volumes without any need to make gain adjustments.



Editing with video editing software and other apps

Recording with 32-bit float WAV file format allows the recording audio quality to be retained when editing.



Dual A/D converter circuit overview

For each input circuit, the M3 has two A/D converters with different input gains. This design enables high-quality audio recording without the need to adjust gain settings, a step that normally had been indispensable.

Providing amazing dynamic range

By combining two A/D converters, a wide dynamic range not possible with a single A/D converter has been realized.

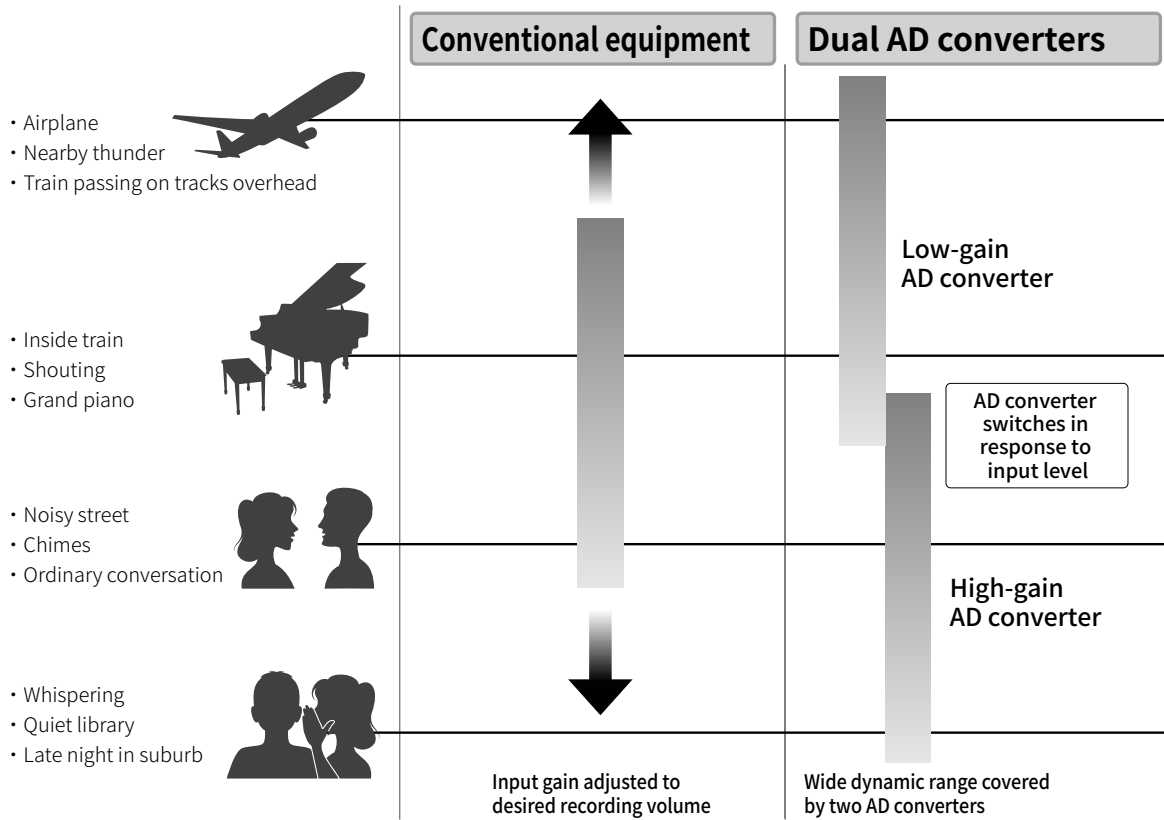

Switching between two A/D converters

The M3 constantly monitors data from the two A/D converters and automatically selects the one that provides the best recording results.

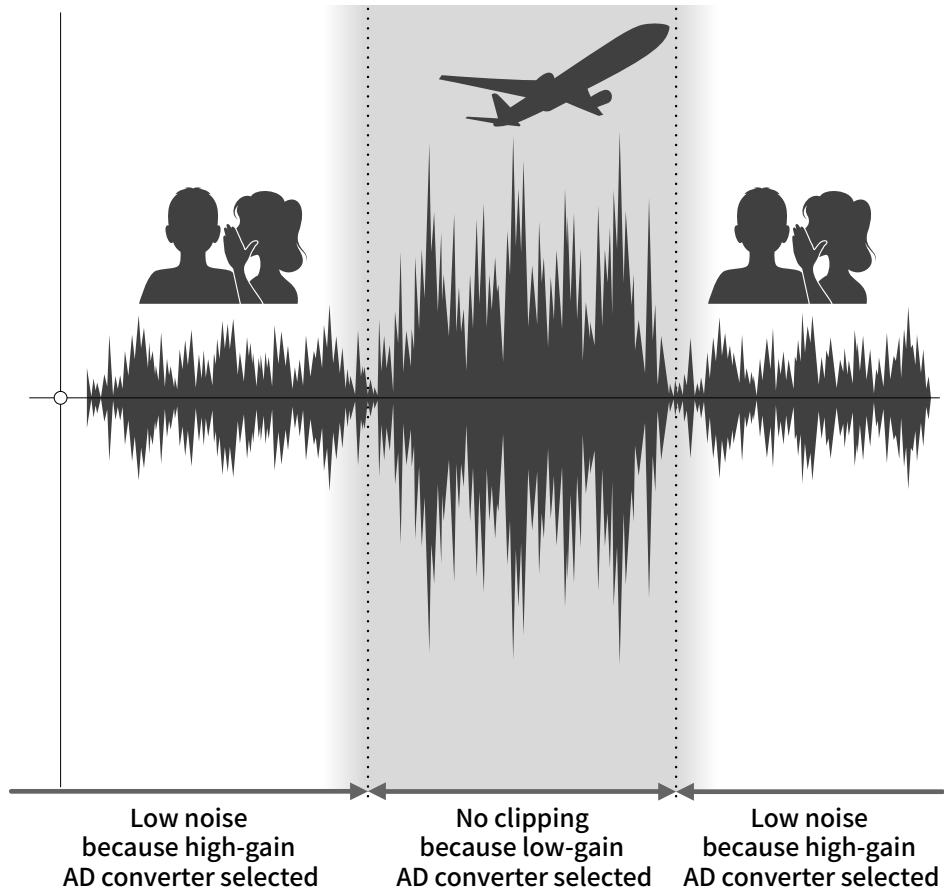

32-bit float WAV file overview

32-bit float WAV files have the following advantages over conventional 16/24-bit WAV files.

These features enable the quality of the sound during recording to be maintained even when editing afterward.

Resolution advantage

32-bit float WAV files have the advantage of being able to maintain high resolution even at low volumes. As a result, quiet sounds can be made louder when editing after recording without degrading their quality.

■ 16/24-bit WAV



■ 32-bit float WAV



Clipping advantage

If a waveform sounds clipped when output from the M3 or in editing software, for example, it can be edited after recording to lower its volume and restore an unclipped waveform because the data in the 32-bit float WAV file itself is not clipped.

■ 16/24-bit WAV

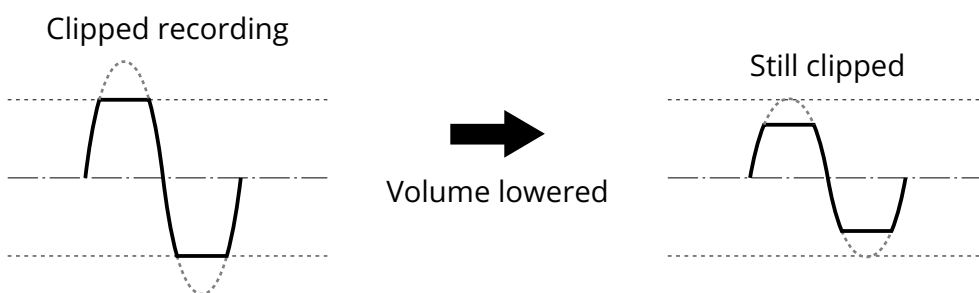

■ 32-bit float WAV

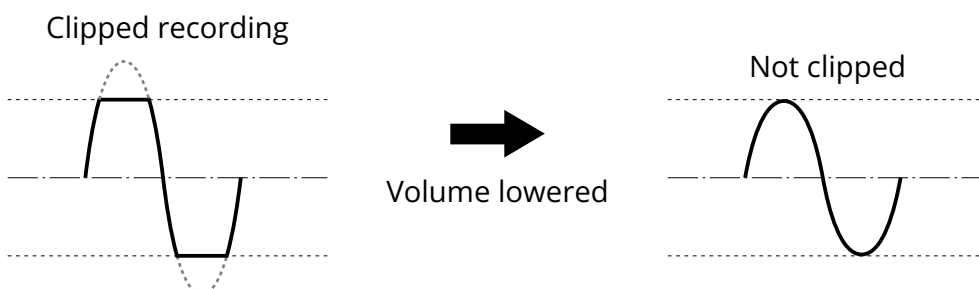

Super directivity realized

With a single mic capsule and an original sound tube structure, a high signal-to-noise ratio and super directivity have been realized. This is ideal for use as a mic mounted on a DSLR camera.

Mid-side format sound capture system

Mid-side format is used to capture stereo audio with mid and side mics. The mid mic captures sound from the front center while the side mic captures sound from the left and right. This is converted to stereo and recorded. The stereo width can be changed by adjusting the side mic recording level at this time.

Moreover, in addition to the normal stereo file, separate mid and side mic signal files (M/S RAW format files) are recorded to the microSD card, so the stereo width can also be adjusted later.

This enables a wide range of recording styles from super-directive mono, which is used frequently, to stereo, which normally would require the preparation of separate mics.

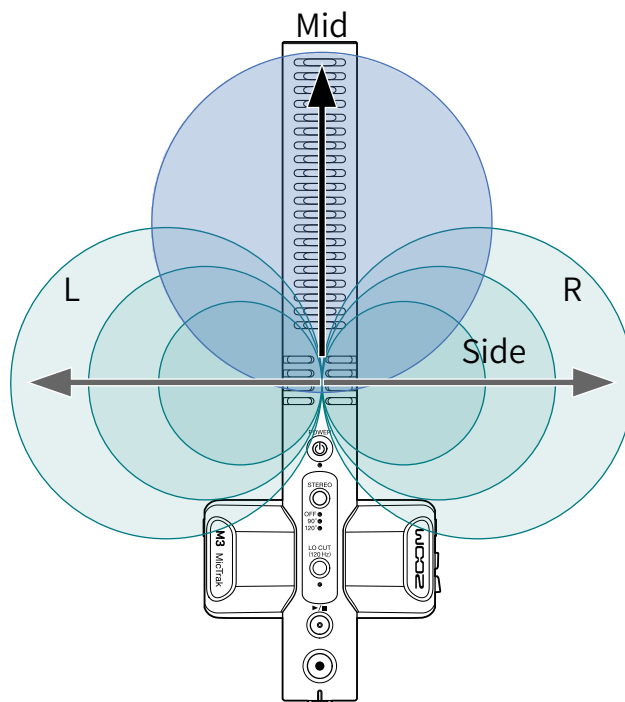

Functions of parts

Top

■ Top

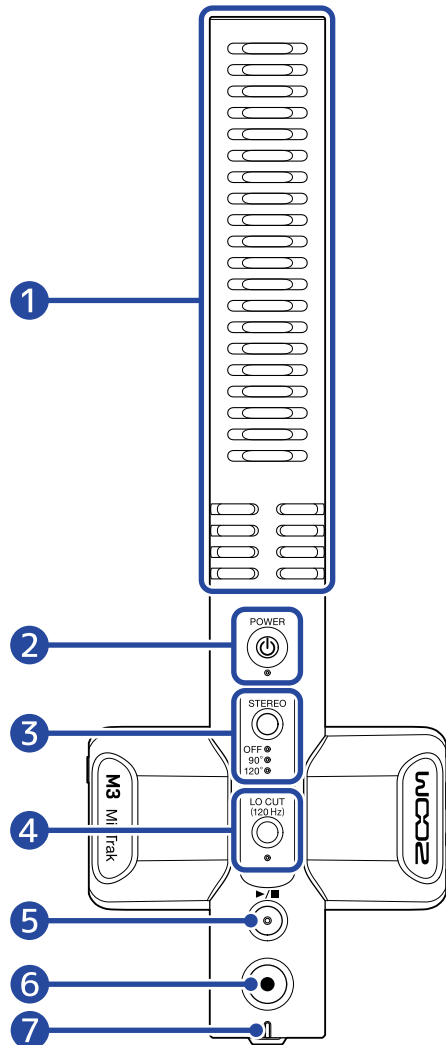

1 Built-in shotgun mic (mid-side format)

This is a super-directional shotgun mic. The inclusion of a side mic enables stereo recording.

2 POWER button/indicator

This turns the power on/off.

When the power is on, the POWER indicator lights as follows.

- Lit green: Remaining battery charge is sufficient or external power supply is connected
- Blinking orange (slowly): Remaining battery charge has become low
- Blinking orange (quickly): Battery charge has become extremely low

3 STEREO button/indicator

This adjusts the stereo width. Pressing this cycles through the settings, which are shown by the indicators.

When set to OFF, the mic can be used as a mono shotgun mic.

4 LO CUT button/indicator

Low frequencies can be cut to reduce the sound of wind and pop noises, for example. The LO CUT indicator lights when the low cut function is on.

5 PLAY/STOP button

This starts and stops playback of the most recently recorded file.

6 REC button

This starts and stops recording.

Pressing and holding this when starting to record will enable record hold mode, which disables all other operations until recording ends. Press and hold the REC button again to stop recording.

7 REC/PLAY indicator

This shows the recording/playback status.

- Recording: Lights red.
- Playing back: Blinks green.

The power status is shown in the same way as the POWER indicator.

Left and right sides

■ Left side

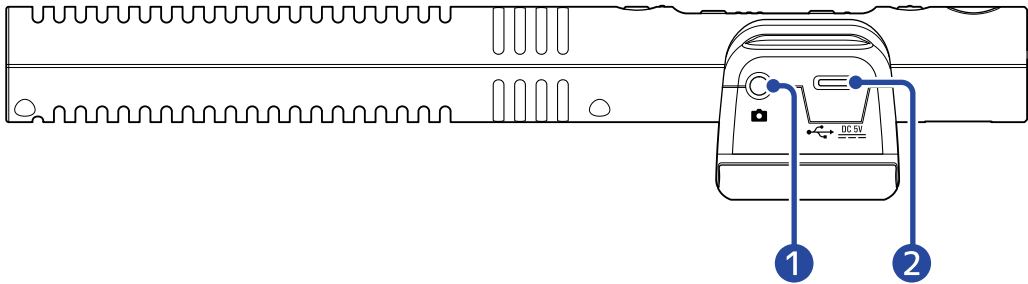

■ Right side

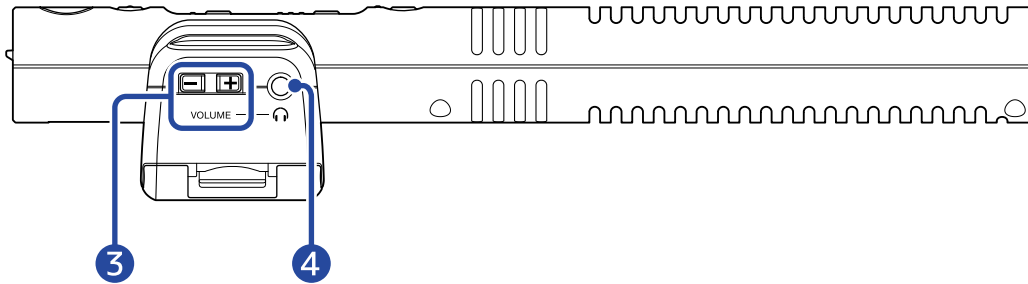

1 LINE OUT jack

This stereo mini jack can be used to output audio. Connect the external input of a DSLR camera or other device here.

2 USB port (Type-C)

This can be used to supply power from an external source, connect to a computer for use as a USB mic and make settings with the dedicated application. This supports operation on USB bus power.

3 HEADPHONE VOLUME buttons

Use these to adjust the headphone volume.

4 PHONE OUT jack

Use this to output sound to headphones.

Front/bottom

■ Front

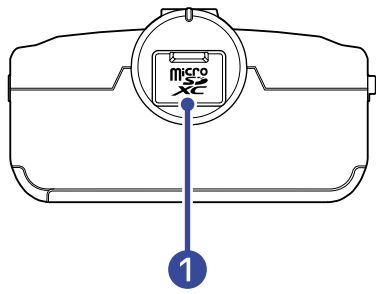

1 microSD card slot

Insert a microSD card here.

■ Bottom

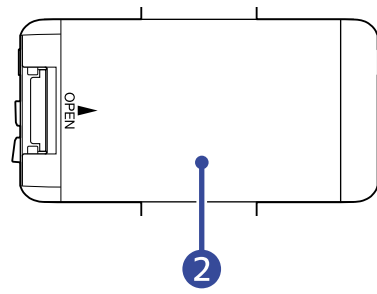

2 Battery compartment cover

Open this when installing or removing AA batteries. (→ [Installing batteries](#))



Recording process

Recording follows the process shown below.

Preparation before recording

- Insert a microSD card (→ [Inserting microSD cards](#))
- Supply power (→ [Installing batteries](#), → [Connecting an AC adapter](#))
- Turn the power on (→ [Formatting the microSD card while starting up](#), → [Starting up without formatting the microSD card](#))
- Connect it to a DSLR camera, for example (→ [Attaching to a camera](#))
- Make hardware settings (→ [Making hardware settings](#))
- Make settings related to input (→ [Making input settings](#))

Recording

- Use  to start recording and  to stop it (→ [Recording](#))

Playing back and reviewing

- Play and check the recording on the M3 or a computer (→ [Playing recordings](#), [Using M3 Edit & Play](#))

Making preparations

Supplying power

The M3 can be powered by batteries or a power supply connected to the USB port (AC adapter, USB bus power or portable battery).

When a power supply is connected to the USB port, it will be used before the batteries.

Installing batteries

To power the M3 with batteries, open the battery cover while pressing it and install two AA batteries.

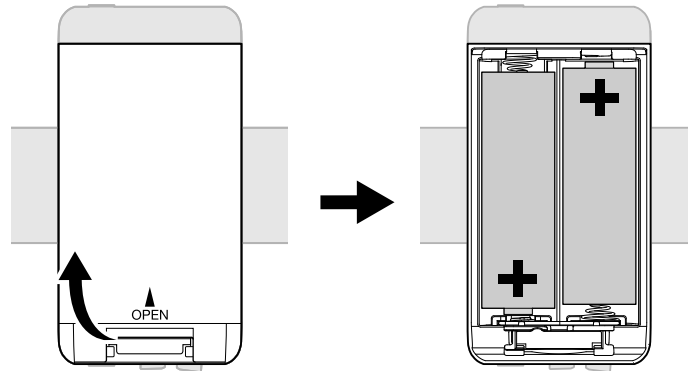

NOTE:

- Use only one type of battery (alkaline, NiMH or lithium) at a time.
- Use the M3 Edit & Play application to set the type of battery used correctly so that the amount of remaining battery charge can be shown accurately. (→ [Setting the type of batteries used](#))
- When the remaining battery charge becomes low, turn the power off immediately and install new batteries. The remaining battery charge can be checked with the POWER and REC/PLAY indicators. (→ [Top](#))

Connecting an AC adapter

Connect the cable of the dedicated AC adapter (AD-17) to the USB port (Type-C), and connect the adapter to an outlet.

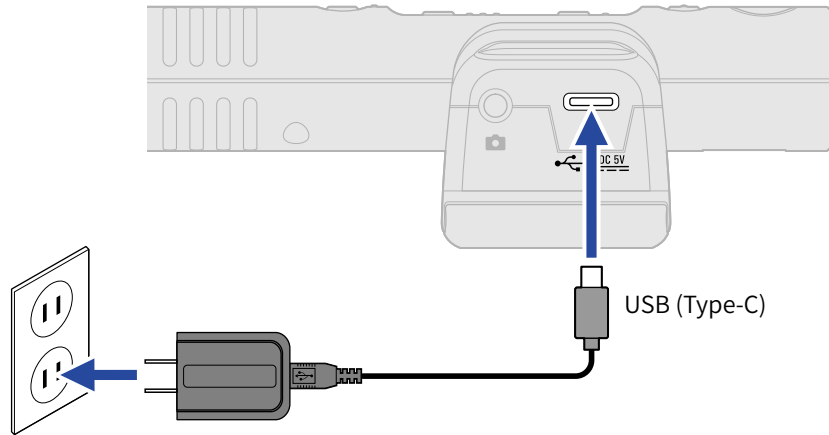

Using other power sources

By connecting a computer to the USB port (Type-C), the M3 can be operated using USB bus power. In addition, a 5V portable battery (commercially-available) can also be used for power.

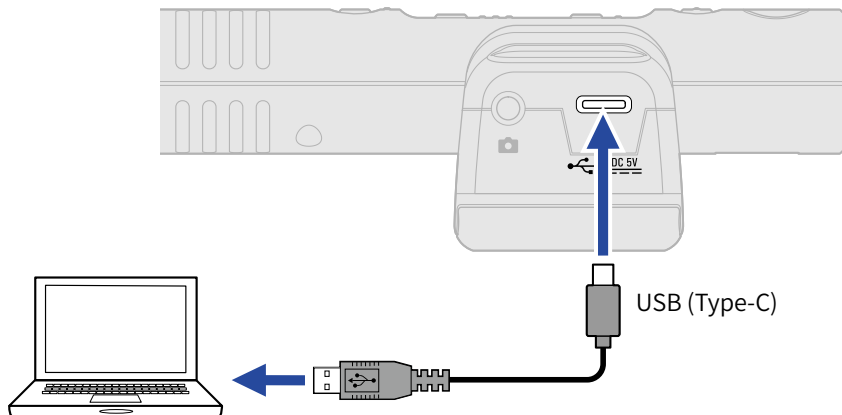

Inserting microSD cards

1. When the power is off, open the microSD card slot cover, and insert a microSD card all the way into the slot with the pins facing up.

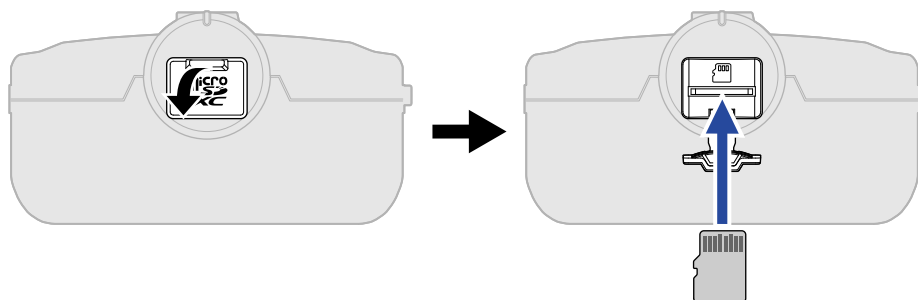

To remove a microSD card, push it further into the slot and then pull it out.



2. Close the microSD card cover.

NOTE:

- Always make certain that the power is off when inserting or removing a microSD card. Inserting or removing a card while the power is on could result in data loss.
- When inserting a microSD card, be sure to insert the correct end with the correct facing.
- Recording and playback are not possible when a microSD card is not loaded in the M3.

Formatting the microSD card while starting up

Before using a microSD card for the first time with the M3, always format it to maximize performance. Using a microSD card that has not been formatted by the M3 could cause dropouts when recording or recording to fail.

1. When the power is off, while pressing , press and hold  .

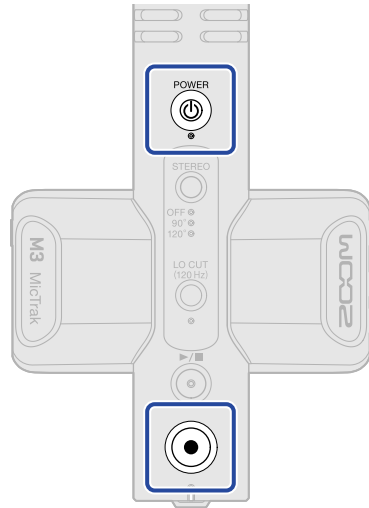

This will start up in a state ready to format the microSD card (POWER, STEREO and LO CUT indicators lit and REC/PLAY indicator blinking).

2. Press  to start formatting.

All the indicators will blink and the microSD card will be formatted.

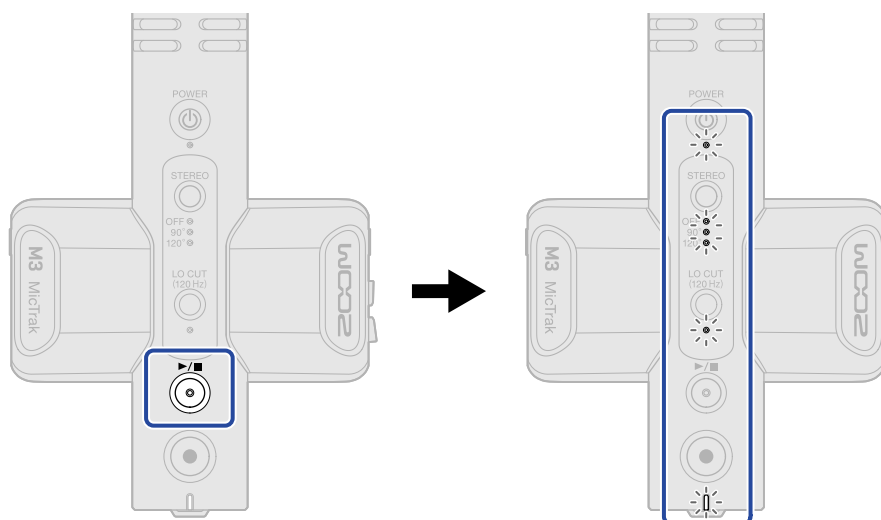

Press any button other than  to cancel formatting.

NOTE:

- Always format microSD cards in order to maximize their performance after purchasing them new or using them with a different device.
- Be aware that all data on the microSD card will be deleted when it is formatted.

Starting up without formatting the microSD card

1. Press and hold  .

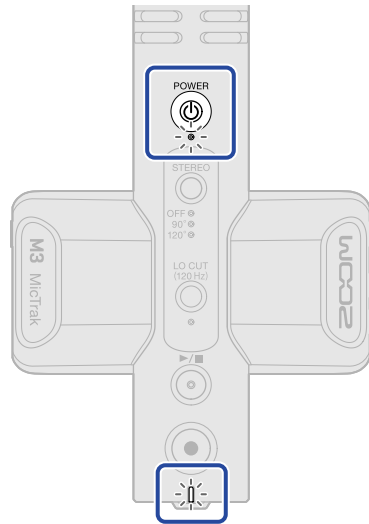

The M3 power will turn on, and the POWER and REC/PLAY indicators will light.

Turning the power off

1. Press and hold  until the POWER indicator becomes unlit.

NOTE:

- When the power is turned off, the current settings will be saved in the M3.
- Do not turn the power off when recording.

Attaching to a camera

Use the included shock mount to use the M3 mounted on a DSLR camera, for example. The shock mount can reduce vibrations and other noise when mounted on a DSLR camera, for example.

1. Attach the M3 to the shock mount

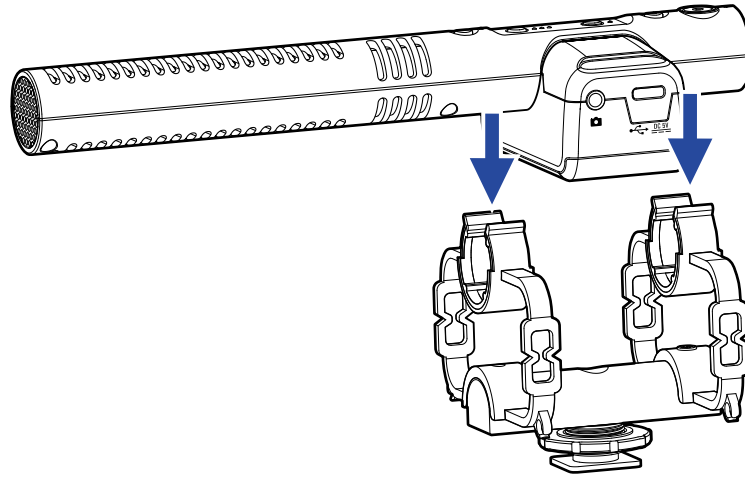

2. Slide the shock mount onto the camera accessory shoe and tighten the screw to attach it.

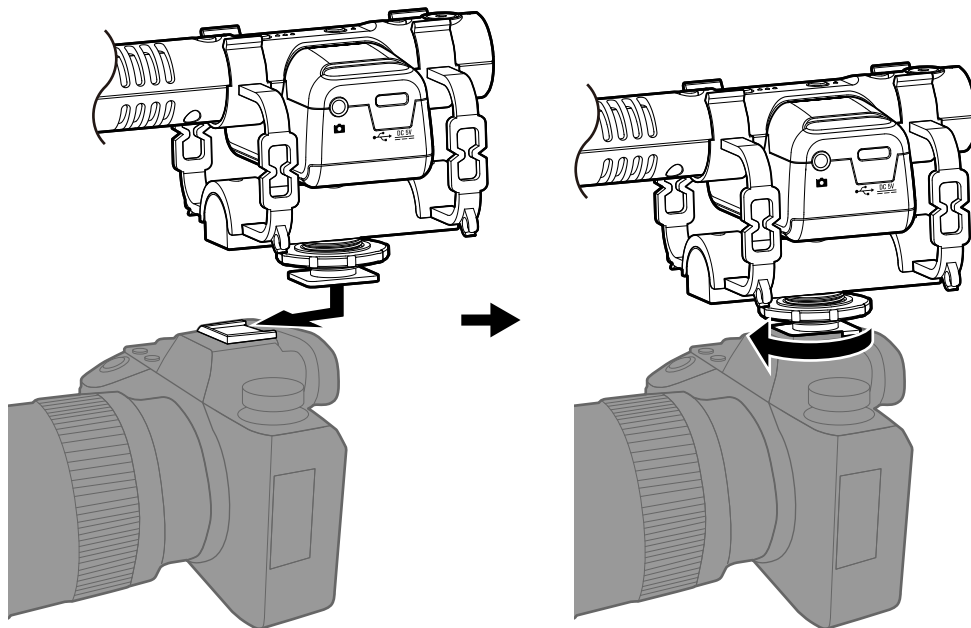

3. Use the included connection cable to connect the LINE OUT jack on the M3 with the external input jack on the camera.

This enables inputting the output sound from the M3 to the camera.

By also recording the M3 sound on the camera, synchronizing with the camera video will be easier when editing.

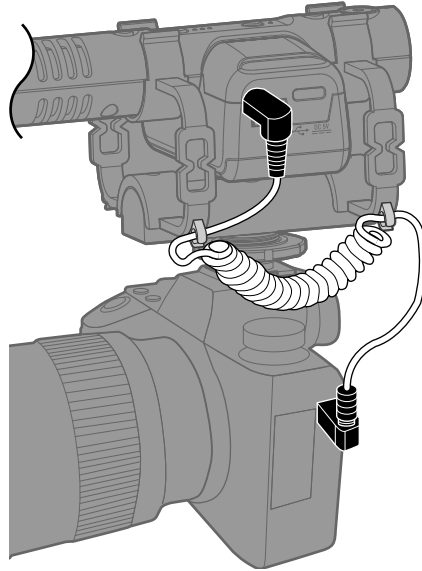

NOTE:

- To prevent vibrations from being transmitted through the connection cable to the M3, secure the cable to the shock mount.
- Adjust the recording level so that the audio does not distort on the camera.

Making hardware settings

Use M3 Edit & Play to make M3 hardware settings (→ [Using M3 Edit & Play](#))

Making input settings

Adjusting the stereo width

The stereo width can be adjusted by changing the side mic level. This setting does not affect the M/S RAW format recording files.

1. Press  to adjust the stereo width.

Pressing this cycles through the settings, which are shown by the indicators.

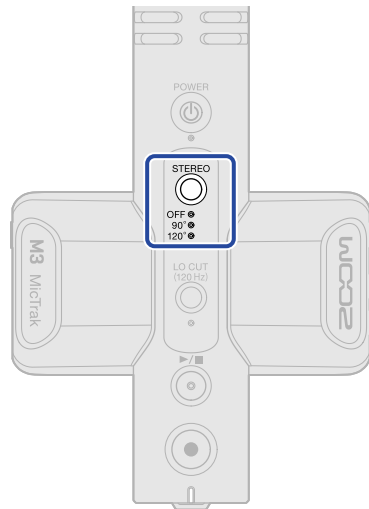

Setting	Explanation
OFF	This turns off the side mic, enabling use as a mono shotgun mic. This is good when capturing only a specific sound source is desired.
90°	This is good when capturing environmental sound is also desired.
120°	This is good when capturing all surrounding sound is desired.

Reducing noise (low-frequency cut)

Low frequencies can be cut to reduce the sound of wind pop noises, for example.

1. Press  to light the indicator.

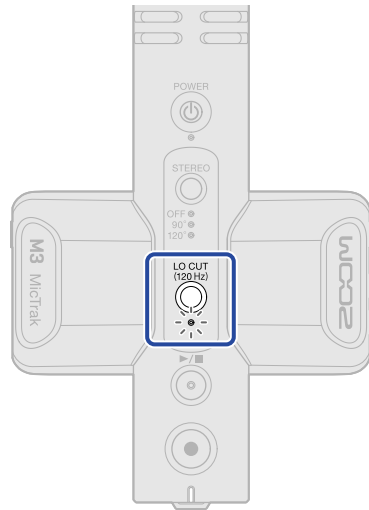

Recording

When recording with the M3, in addition to recording files that mix in side mic signals to capture stereo, RAW format files that capture signals from the mid and side mics as is are also recorded on the microSD card.

The stereo width can be adjusted later using the M/S RAW format files.

Monitoring input sounds

Input sounds can be monitored using headphones, for example, and the monitoring volume can be adjusted.

1. Connect headphones, for example, to the PHONE OUT jack.

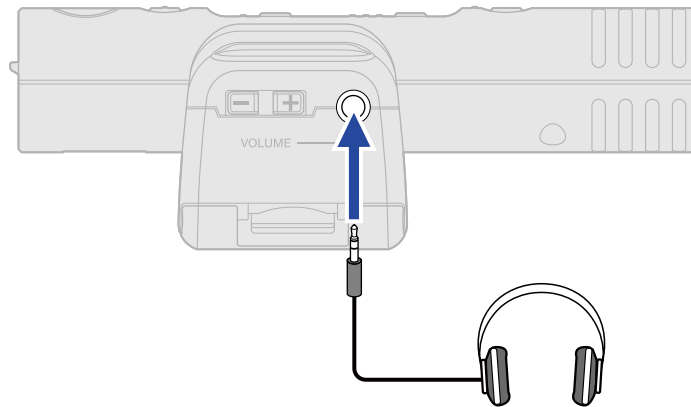

2. Use   to adjust the volume.

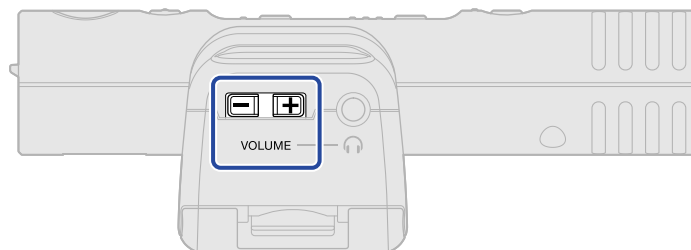

NOTE:

The headphone volume setting does not affect the recording level.

HINT:

The M3 is a mic with focused directionality. We recommend monitoring the sound with headphones to ensure accurate miking.

Recording

1. Press .

The REC/PLAY indicator will light red and recording will start.

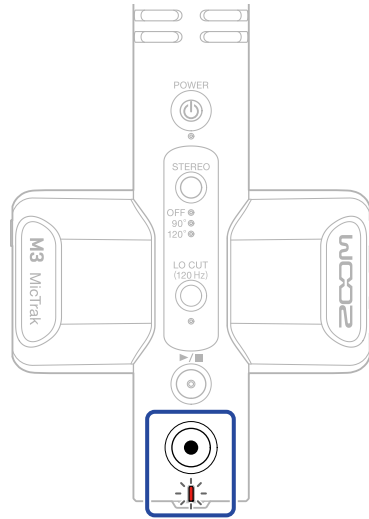



NOTE:

If the remaining battery charge becomes low while recording, the REC/PLAY indicator will blink orange.

2. Press  to stop.

HINT:

By pressing and holding  when starting recording, all other operations can be disabled while recording (REC HOLD). This can prevent misoperation during recording, including accidentally changing settings or stopping recording unintentionally.

When the REC HOLD function is active, pressing and holding  again will deactivate the function and stop recording.

Playing recordings

The most recently recorded file can be played back.

1. Connect headphones, for example, to the PHONE OUT jack.

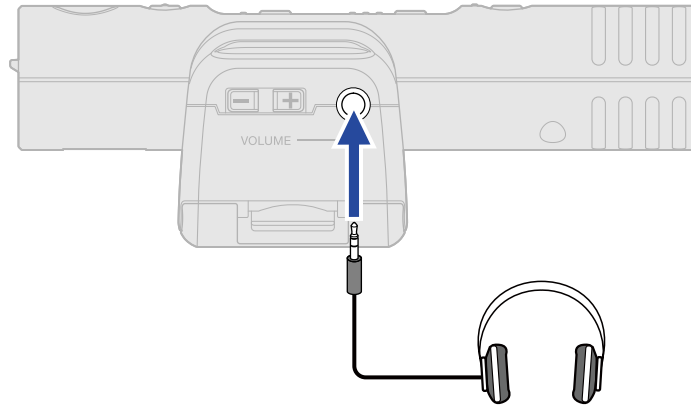

2. Press .

The REC/PLAY indicator will blink green and playback will start.

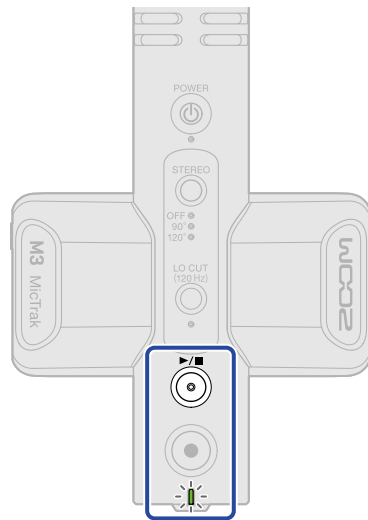

3. Press  to stop playback.

HINT:

Using the M3 Edit & Play application, the stereo width of M/S RAW format recording files can be adjusted precisely as they are played back and exported as stereo files. (→ [Using M3 Edit & Play](#))

Managing files

Files created by the M3 are saved on the microSD card.

M3 folder and file structure

Folder and file structure

When recording with the M3, files are created on microSD cards in the following manner.

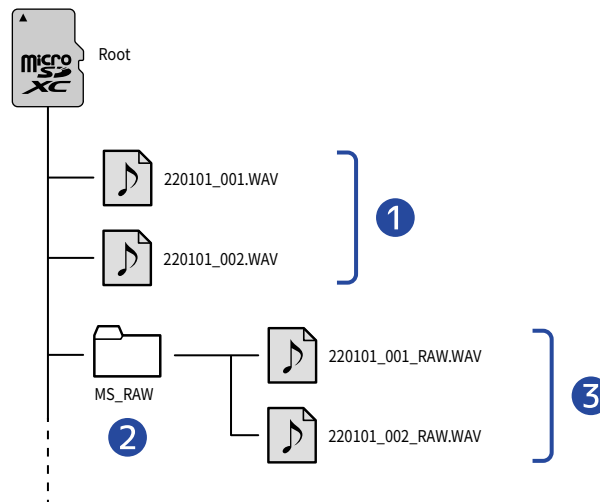

1 Stereo files

Normal stereo files are created using the set stereo width in the root folder of the microSD card. When stereo width is set to OFF, the same signal is recorded to both left and right channels. (→ [Adjusting the stereo width](#))

2 MS_RAW folder

M/S RAW format files are created here.

3 M/S RAW files

M/S RAW format files are created with the mid mic signal on track 1 and the side mic signal on track 2. The stereo width can be adjusted later using the M3 Edit & Play application. (→ [Using M3 Edit & Play](#))

Recording file naming

File names are assigned in the following format.

File name example	Explanation
<p>20220101_001.WAV</p> <p>1 2</p>	<ul style="list-style-type: none">① Date The set date is used.② Take number This number is increased by one every time recording is started anew.

Transferring files to computers

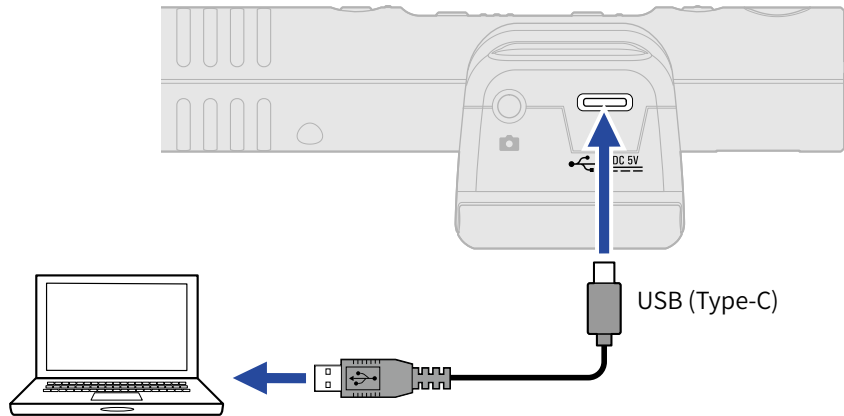

By connecting the M3 to a computer, files on the microSD card can be checked and moved. Start the M3 in File Transfer mode to connect it to a computer.

1. Use a USB cable (Type-C) to connect the M3 and the computer.



NOTE:

Use a USB cable that supports data transfer.

2. When the power is off, while pressing , press and hold .

The REC/PLAY will light orange and the M3 will start in File Transfer mode.

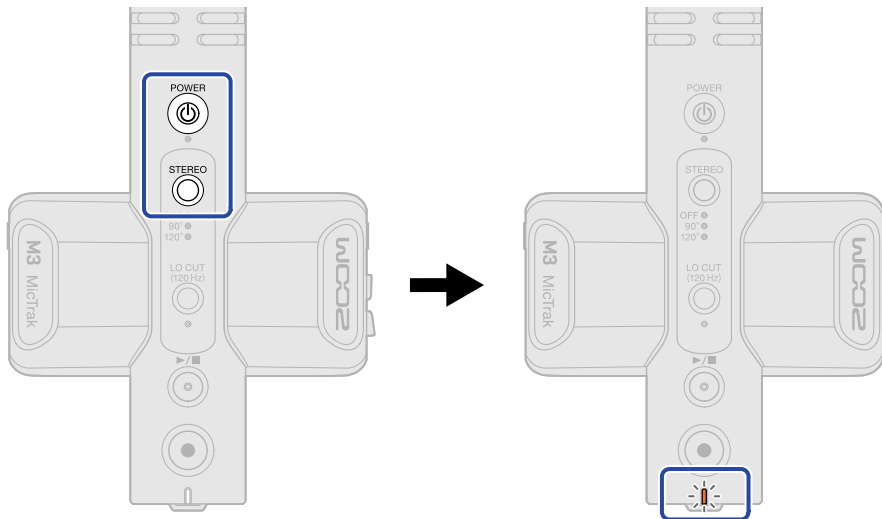

NOTE:

When in File Transfer mode, normal functions, including sound input/output, recording and playback cannot be used.

3. Use the computer, smartphone or tablet to work with files saved on the microSD card.

Disconnecting from a computer

1. Disconnect on the computer.

- Windows:
Select the M3 from "Safely Remove Hardware and Eject Media".
- macOS:
Drag the M3 icon to the Trash and drop it.

2. Disconnect the USB cable connecting the M3 and the computer.

NOTE:

Always conduct step 1 before disconnecting the USB cable.

3. Turn the M3 power off.

Using as a USB mic

Signals input to the M3 can be sent to computers, smartphones and tablets, and playback signals from these devices can be output from the M3.

Moreover, the M3 can also record audio while being used as a USB mic.

Connecting computers, smartphones and tablets

1. Use a USB cable (Type-C) to connect the M3 to the computer, smartphone or tablet.
If connecting with an iPhone, see “When connecting with an iPhone” below.

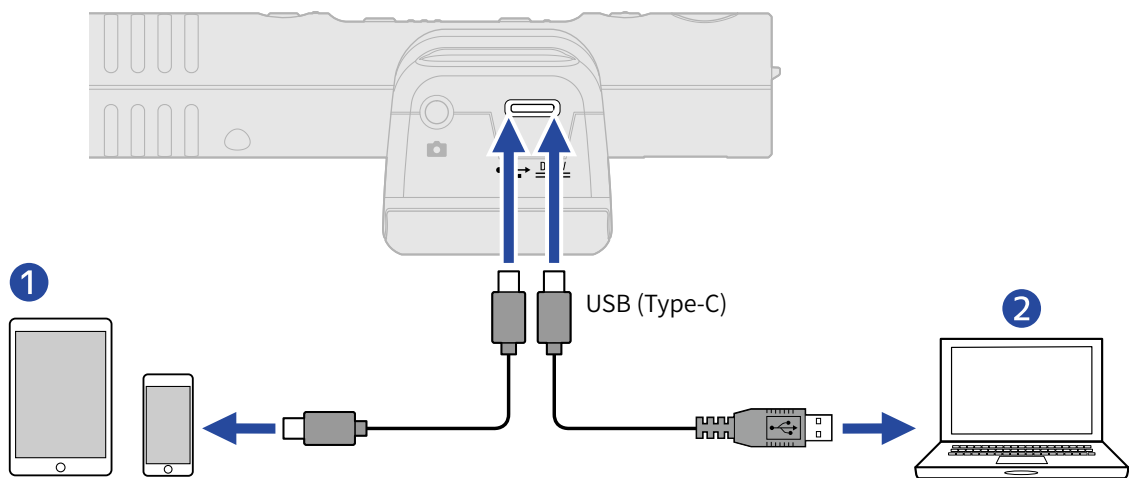

- 1 Smartphone/tablet (Android, iPad with a Type-C connector)
- 2 Computer (Windows/Mac)

NOTE:

- Use a USB cable that supports data transfer.
- Operation will be fixed at 48kHz/24-bit.
- Connection is possible with devices that can supply 5V/1A power, including Android devices and iPads with Type-C connectors.

When connecting with an iPhone:

Follow the procedures below to connect with an iPhone.

1. Power the M3 with batteries.
2. Use a Lightning to USB Camera Adapter to connect the M3 and the iPhone.

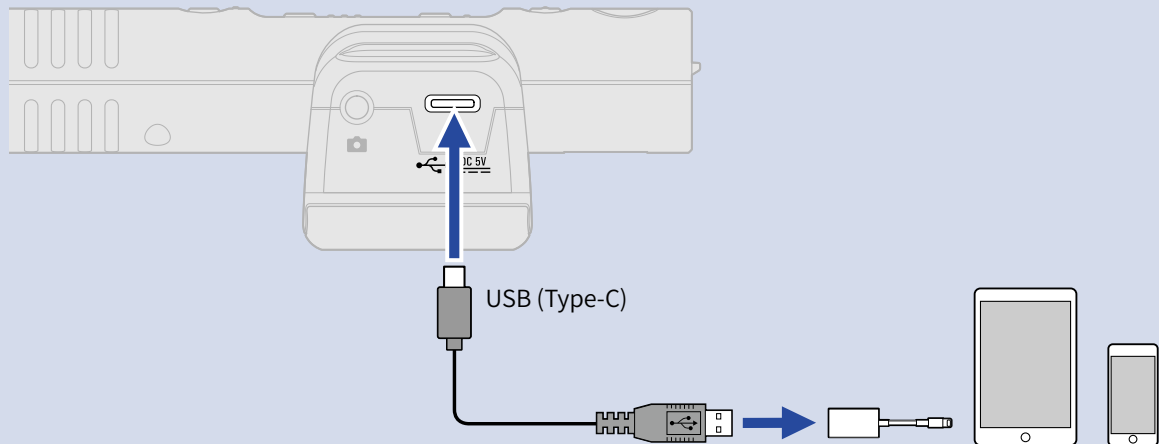

NOTE

- Do not record or play files when using connected to an iPhone. The M3 power could fail and connection with the iPhone could be interrupted.
- When using a Lightning to USB 3 Camera Adapter, provide power with an external power supply.

HINT:

While being used as a USB mic, the stereo width can be adjusted (→ [Adjusting the stereo width](#)) and low-frequency noise can be cut (→ [Reducing noise \(low-frequency cut\)](#)).

Managing the firmware

Checking the firmware version

Use the M3 Edit & Play application to check the firmware version. (→ [Using M3 Edit & Play](#))

Updating the firmware

The M3 firmware can be updated to the latest version.

Files for the latest firmware updates can be downloaded from the ZOOM website (zoomcorp.com).

Follow the instructions in the “M3 Firmware Update Guide” on the M3 download page.

Using M3 Edit & Play

M3 Edit & Play is a computer application that can be used, for example, to make M3 settings as well as to adjust the volume and stereo width of M/S RAW format files recorded by the M3 and export them as ordinary stereo files.

M3 Edit & Play screen overview

When M3 Edit & Play launches, the screen shown below appears. See the reference links for details about each function.

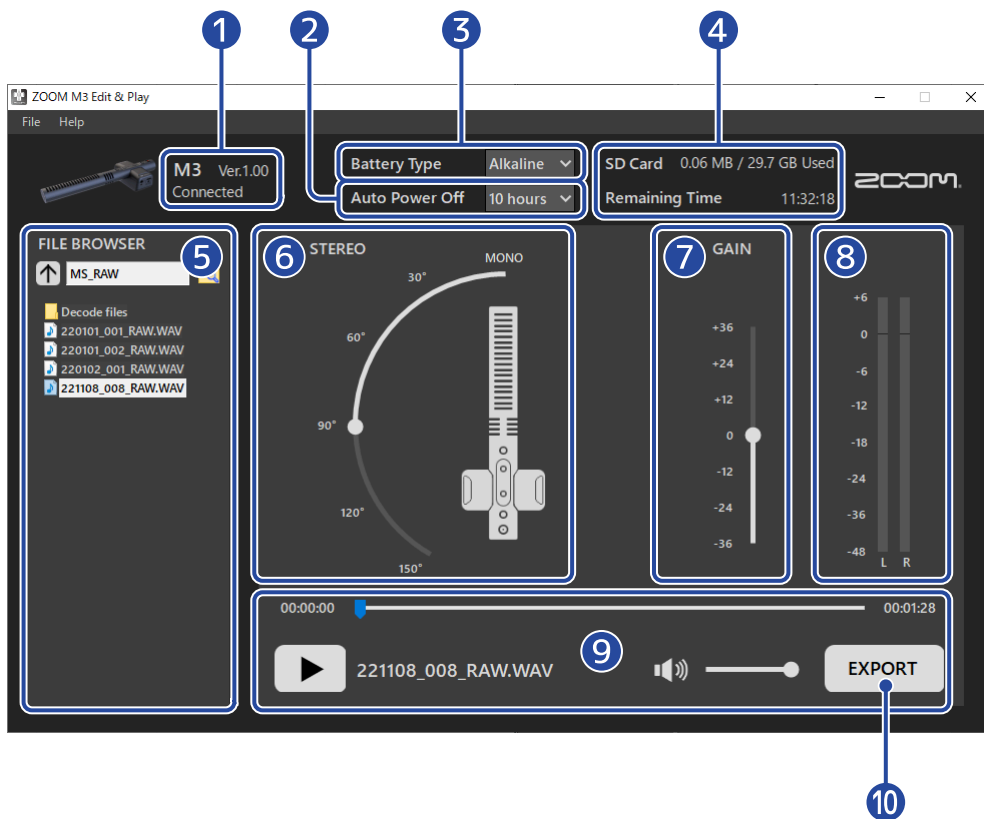

- 1 Connection status**

This shows the connection status of the M3. The firmware version used by the M3 can be checked when it is connected. (→ [Checking the firmware version](#))
- 2 Auto Power Off**

Use this to set the time without use until the M3 power turns off automatically. (→ [Setting the time until the power turns off automatically \(Auto Power Off\)](#))
- 3 Battery Type**

Select the type of batteries used in the M3. (→ [Setting the type of batteries used](#))

- 4 SD card**
This shows the remaining space and remaining recordable time on the microSD card loaded in the M3. (→ [Checking the remaining space on the microSD card](#))
- 5 File browser**
Use this to browse WAV files on the computer and select files to adjust in M3 Edit & Play. (→ [Selecting files](#))
- 6 Stereo width setting**
Use this to adjust the stereo width of M/S RAW format files recorded by the M3. (→ [Setting the stereo width](#))
- 7 Gain setting**
Use this to adjust the volume of recording data. (→ [Adjusting the gain](#))
- 8 Level meters**
Use these to check the volume during playback. (→ [Checking levels](#))
- 9 Playback area**
Control playback in this area. (→ [Playing files](#))
- 10 Export button**
Use this to export regular stereo files using the stereo width and gain settings adjusted in M3 Edit & Play. (→ [Using the export function](#))

Installing M3 Edit & Play

1. Download M3 Edit & Play to the computer from zoomcorp.com.

NOTE:

The latest version of M3 Edit & Play can be downloaded from the above website.

2. Installing M3 Edit & Play on the computer
Follow the instructions in the Installation Guide to install it.

Making and checking various M3 settings

Connect the M3 to a computer to make and check various M3 settings.

1. Turn the M3 the power on (→ [Formatting the microSD card while starting up](#), → [Starting up without formatting the microSD card](#)).
2. Use a USB cable (Type-C) to connect the M3 and the computer.

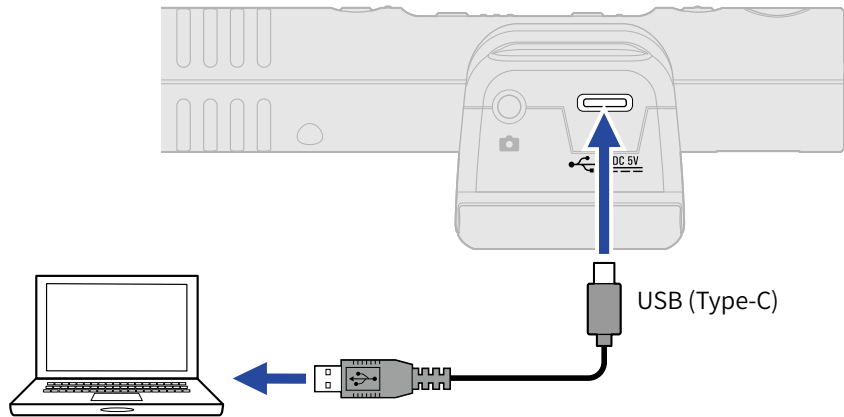

NOTE:

Use a USB cable that supports data transfer.

3. Launch M3 Edit & Play, and confirm that “Connected” appears.



Setting the date and time

When connected to a computer, the M3 will automatically be set to the date and time used by the computer.

The date is written to recording files.

Setting the type of batteries used

Set the type of battery used by the M3 correctly so that the amount of remaining battery charge can be shown accurately.

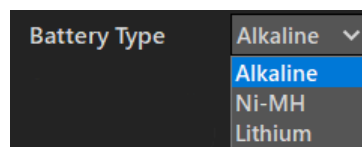

Setting	Explanation
Alkaline	Alkaline batteries

Setting	Explanation
Ni-MH	Nickel-metal hydride batteries
Lithium	Lithium batteries

Setting the time until the power turns off automatically (Auto Power Off)

The M3 can be set to automatically turn off if it is not operated for a specific amount of time. To keep the power on at all times, set Auto Power Off to Never.

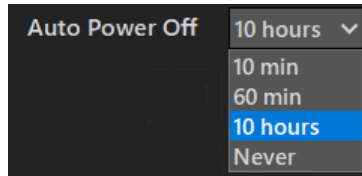

Setting	Explanation
10 min	The power will automatically turn off if it is unused for 10 minutes.
60 min	The power will automatically turn off if it is unused for 60 minutes.
10 hours	The power will automatically turn off if it is unused for 10 hours.
Never	The power will never turn off automatically

Checking the remaining space on the microSD card

The remaining space and remaining recordable time on the microSD card can be checked.

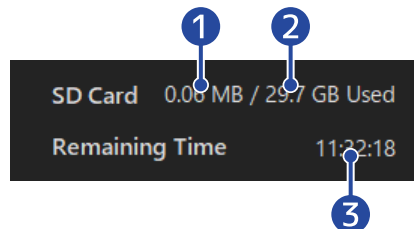

- 1 Amount of microSD card space used
- 2 microSD card capacity
- 3 Recordable time

Checking the firmware version

The firmware version used by the M3 can be checked.



Selecting files

The file browser can be used to browse WAV files on the computer and to select files to play and adjust. Files recorded on devices other than the M3 cannot be selected.

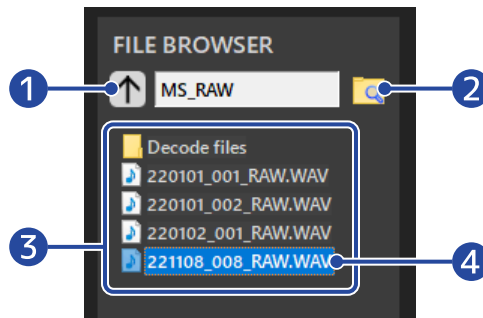

- 1 Move to the folder up one level**
Click this to move to the folder one level above.
- 2 Select folder**
Click the folder icon to select the folder to open.
- 3 WAV files and folders inside the folder currently shown**
Double-click one to open it.
- 4 Selected file**
The selected file is shown highlighted.

Playing files

Use the playback area to play files. (→ [M3 Edit & Play screen overview](#))

Use the file browser to select the desired file for playback. (→ [Selecting files](#))

The stereo width and gain can be adjusted while the file is playing.

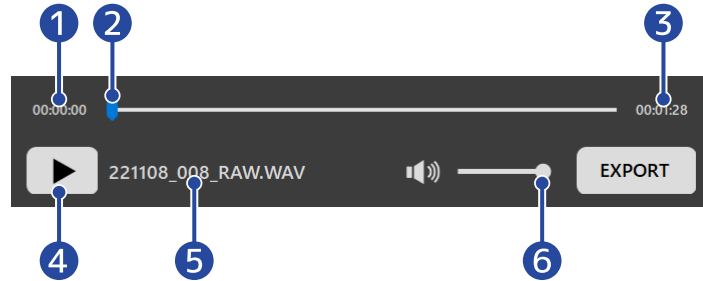

1 Time at playback position

2 Playback position

The playback position can be changed by clicking or dragging.

3 File length

4 Play/pause button

Click to start/pause playback.

5 Name of file currently playing

6 Playback volume

The playback volume can be adjusted by clicking or dragging. This does not affect the volume of exported files. (See "[Adjusting the gain](#)" to adjust the volume of exported files.)

Setting the stereo width

Use this to adjust the stereo width of M/S RAW format files recorded by the M3. This cannot be adjusted for ordinary stereo files.

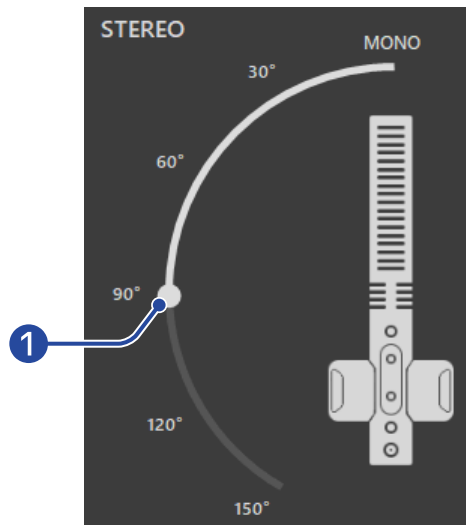

1 Stereo width

Drag the slider to adjust it. Increasing the angle strengthens the stereo sound.

Numbers next to the slider (90° for example) can be clicked to move the slider to that position.

Adjusting the gain

The volumes of files recorded by the M3 can be adjusted.

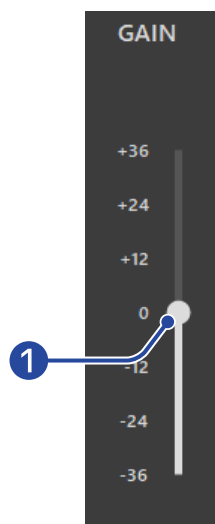

1 Volume

Drag the slider to adjust the volume.

Numbers next to the slider (+12 for example) can be clicked to move the slider to that position.

Double-click it to move the slider to the 0 position.

Checking levels

The volume can be checked in real time during playback.

The level changes according to the stereo width and gain settings.

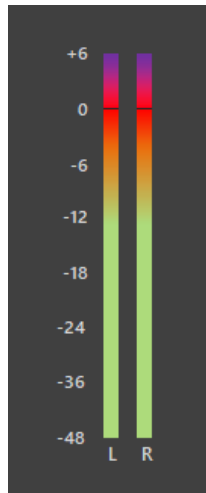

NOTE:

If this exceeds 0 dB, exporting in 24-bit linear format will result in clipping. (→ [Using the export function](#))

Using the export function

Regular stereo files can be exported after adjusting the stereo width and volume of files recorded with the M3.

1. Select the file to export (→ [Selecting files](#)).
2. Adjust the stereo width and volume while playing it back (→ [Playing files](#)).
3. Click the EXPORT button.

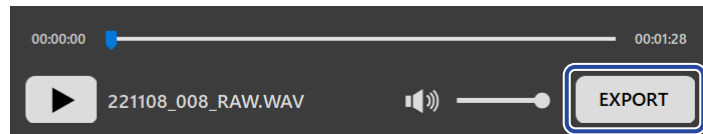

4. Make export settings.

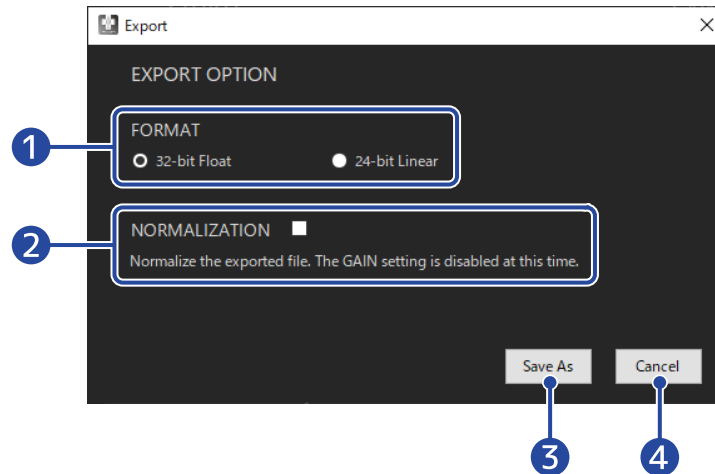

- 1 **Export format**
Select whether to export in 32-bit float or 24-bit linear format.
- 2 **Normalization setting**
This setting enables the normalization function when exporting. Check this box to enable normalization and disable the gain setting.
Normalization adjusts the volume so that the data peaks at 0 dB.
- 3 **Save button**
Press to proceed to step 5 and save the file.
- 4 **Cancel**
Cancel saving and return to the previous screen.

5. Input the file name in the save dialog and save the file.

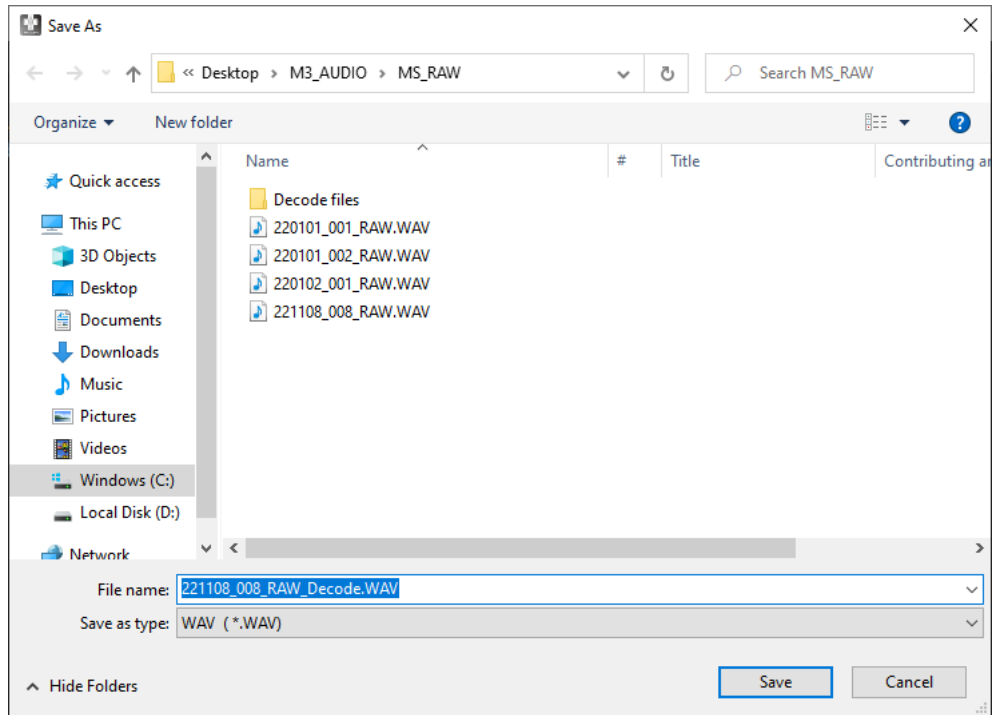

M3 Edit & Play application menu

The application menu at the top left can be used to see information about the app and access the manual.

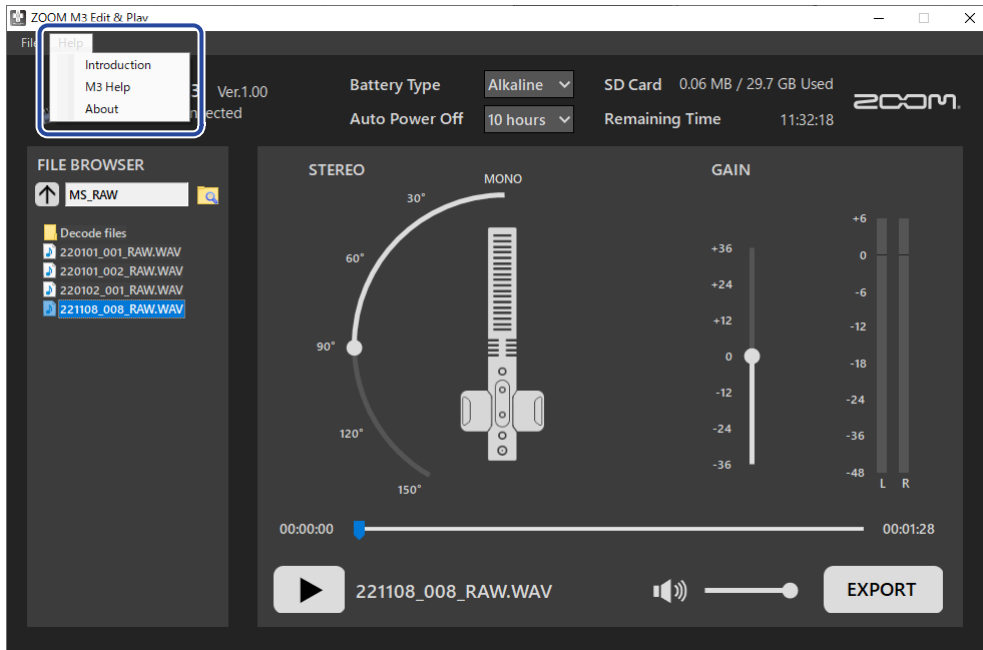

M3 Edit & Play information

Information about the application can be viewed.

In Windows, select Help > About.

In Mac, select ZOOM M3 Edit & Play > About ZOOM M3 Edit & Play.

Help

M3 documents can be checked on the Internet.

Select Help > M3 Help.

Appendix

Troubleshooting

If you think that the M3 is operating strangely, check the following items first.

Recording/playback trouble

Power will not turn ON

- Check the power supply. (→ [Supplying power](#))



There is no sound or output is very quiet

- Check the mic orientation.
- Check the connections. (→ [Attaching to a camera](#))
- Check the headphone volume. (→ [Monitoring input sounds](#))

Recording is not possible or sound breaks up

- Confirm that the REC/PLAY indicator is lit red. (→ [Recording](#))
- Confirm that the microSD card has open space. M3 Edit & Play can be used to check the available recording time. (→ [Checking the remaining space on the microSD card](#))
- Confirm that a microSD card is loaded properly in the card slot. (→ [Inserting microSD cards](#))
- Use the M3 mic to format the microSD card. (→ [Formatting the microSD card while starting up](#))

Cannot stop recording

- Pressing and holding  to start recording will activate REC HOLD mode, which disables the use of other buttons. Press and hold  to stop recording. (→ [Recording](#))

Other trouble

The recorder is not recognized by a computer, smartphone or tablet even though the USB port is connected to it.

- Use a USB cable that supports data transfer.
- Check the audio input and output device settings.

Battery operation time is short

Making the following settings could increase the battery operation time.

- Set the type of batteries used correctly. (→ [Setting the type of batteries used](#))
- Disconnect unnecessary cables from the PHONE OUT and LINE OUT jacks.

- Due to their characteristics, using nickel metal hydride batteries (especially high-capacity ones) or lithium batteries should enable longer use than alkaline batteries when power consumption is high.

Specifications

Inputs	Mid mic (Mono shotgun)	Directionality	Super cardioid
		Input gain	Adjustment unnecessary (dual A/D converter circuit used)
		Maximum sound pressure input	133 dB SPL
	Side mic	Directionality	Bidirectional
		Input gain	Adjustment unnecessary (dual A/D converter circuit used)
		Maximum sound pressure input	119 dB SPL
Outputs	LINE OUT	Connector	3.5 mm stereo mini jack
		Maximum output level	+1.2 dBu (into 2 k Ω load)
		Output impedance	100 Ω
	PHONE OUT	Connector	3.5 mm stereo mini jack
		Maximum output level	20 mW + 20 mW (into 32 Ω load)
		Output impedance	10 Ω
Recorder		Maximum simultaneous recording tracks	4
		Maximum simultaneous playback tracks	2
		Recording format	WAV 48 kHz, 32-bit float stereo BWF format supported
		Recording media	4–32GB cards compatible with the microSDHC specification 64GB–1TB cards compatible with the microSDXC specification
USB	Connector	USB Type-C • Use a USB cable that supports data transfer. USB bus power is supported.	
	USB mic	USB 2.0 High Speed 48 kHz, 24-bit 2-in/2-out	
	File transfer	USB 2.0 High Speed	

Power		2 AA batteries (alkaline, lithium, or rechargeable NiMH) AC adapter (ZOOM AD-17): DC 5 V/1 A • USB bus power is supported.
Estimated continuous operation times using batteries	No headphones connected, LINE OUT connected to camera	Alkaline batteries: about 12 hours NiMH batteries (1900 mAh): about 11 hours Lithium batteries: about 21 hours
<ul style="list-style-type: none"> • These values are approximate. • Continuous battery operation times were determined using in-house testing methods. They will vary greatly according to use conditions. • These are times until the POWER indicator blinks orange (rapidly). 		
Rated current	Batteries	234 mA
	USB bus power/DC 5V power supply	186 mA
Power consumption		1.5 W maximum
Dimensions		71.6 mm (W) × 201.3 mm (D) × 38 mm (H)
Weight (including batteries)		135 g

Note: 0 dBu = 0.775 Vrms



ZOOM CORPORATION

4-4-3 Kanda-surugadai, Chiyoda-ku, Tokyo 101-0062 Japan
zoomcorp.com